

Godox 神牛

SK II 影室闪光灯

Compact Studio Flash



深圳市神牛摄影器材有限公司
GODOX Photo Equipment Co., Ltd.

地址/Add: 深圳市宝安区福海街道塘尾社区耀川工业区厂房2栋1层至4层、4栋1层至4层
1st to 4th Floor, Building 2/ 1st to 4th Floor, Building 4, Yaochuan Industrial Zone,
Tangwei Community, Fuhai Street, Bao'an District, Shenzhen 518103, China

电话/Tel: +86-755-29609320(8062)

传真/Fax: +86-755-25723423

邮箱/E-mail: godox@godox.com

<http://www.godox.com>

705-SK2000-00

Made In China



Instruction Manual
说 明 手 册

Chinese English Bilingual | 中英文双语

FOREWORD

Thanks for choosing SKIL series studio flash. It is a lightweight, compact and durable flash with complete functions. Design for shooting studio portrait and e-commerce product. This product is suitable for head shot, waist shoot, and certificate photography, as well as product shooting, etc. It can also offer high light, background light, or hair light in large studios and workshops. The SKIL flash offers:

- Built-in Godox 2.4G wireless X system
- Precise output displayed on LCD panel, 40 steps from 1/16 to 1/1 (or 6.0 to 10.0)
- Use optional X1, XT16 or FT-16 trigger to control the flash power ratio, modeling lamp and buzzer, as well as flash triggering
- Compact and lightweight body with Bowens mount to add almost any studio light shapers
- 150W modeling lamp adjusts in 5% to 100% power levels
- Outstanding output stability, no more than 2% shifts when under the same output
- Anti-preflash function enables synchronization with cameras that have a one-preflash firing system
- Auto memory and recovery of adjusted panel settings

CONTENTS

09	Foreword	14	• Slave Trigger Model
10	Warning	15	• Buzz Function
10	Caution	15	• Key Combination
11	Names of Parts	15	• Alarm Display
11	• Body	15	• Memory Function
12	• LCD Panel	15	• Wireless Control Function
12	• Accessories	17	• Tube Replacement
12	• Separately Sold Accessories	17	Technical Data
13	Operations	18	Maintenance
13	• Flash Preparation		
13	• Power Connection		
13	• Modeling Lamp		
14	• Power Output Control		
14	• Test Button		
14	• Sync Triggering		
14	• GR/CH Button		

Warning

To prevent damage to the product or injury to you or to others, read the following warnings in their entirety before using this product. Keep these safety instructions where users can read them for ready reference.

- ▲ Do not disassemble or modify. Should the product break down, send the defective back to the authorized service center for inspection and maintenance.
- ▲ Keep dry. Do not handle with wet hands, immerse in water, or expose to rain.
- ▲ Keep out of reach of children.
- ▲ Please put the device in a ventilation environment and keep the parts of lighting and heat dissipation holes are unobstructed. Do not use in flammable environment.
- ▲ As this product adopts make and break device, please keep it easy to be used.
- ▲ No touching the heating parts of this product.
- ▲ Please turn off the power and wear insulated gloves before installing and connecting accessories. When replacing the tube or modeling lamp, please make sure that the tube is cool and wear insulated gloves to prevent burns.
- ▲ Do not flash directly towards naked eyes (especially those of babies), otherwise it may lead to visual impairment.
- ▲ Disconnect from the power supply when it will not be used for an extended period.
- ▲ For continued protection against risk of fire replace only with same Type F8AL 250V fuse.
- ▲ An apparatus with CLASS I construction shall be connected to a MAINS socket outlet with a protective earthing connection.
- ▲ The MAINS plug or an appliance coupler is used as the disconnect device, the disconnect device shall remain readily operable.
- ▲ After 30 continuous flashes at full power, the flash should be cooled down for about 3 minutes. Overheating will occur if it is used continuously without cooling down.
- ▲ Do not keep using the modeling lamp for a long time; otherwise flammable accessories attaching to flash head, e.g. softbox will get burnt. A 10-minute time is recommended in this case. After 10 minutes, cool it down for 1 minute.
- ▲ When using a snoot, do not keep the modeling lamp on for a long time or fire too frequently (not over six times for one minute). Overheating will result in damages for strobe housing and/or studio light.
- ▲ Avoid sudden impacts as this can damage the flash tube and/or modeling lamp.
- ▲ The apparatus shall not be exposed to tripping or splashing and that no objects filled with liquids, such as vases, shall be placed on the apparatus.
- ▲ Do not touch the area around this symbol since it is hot.

NAMES OF PARTS

• Body

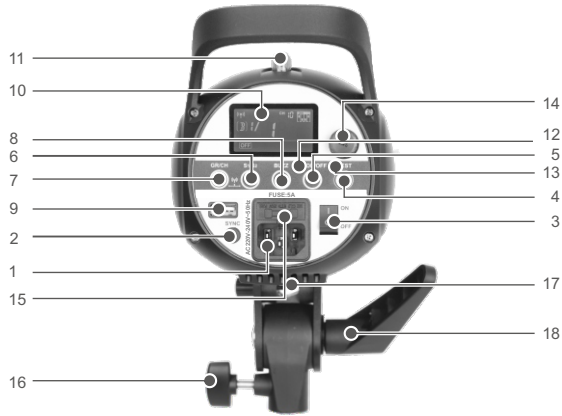

- | | |
|---------------------------------|--------------------------------|
| 1. AC Power Socket | 10. LCD Display |
| 2. Sync Cord Jack | 11. Light Sensor |
| 3. Power Switch | 12. Modeling Lamp Indicator |
| 4. Test Button | 13. Test Indicator |
| 5. MOD/OFF Modeling Lamp Button | 14. Select Dial + SET Button |
| 6. S1/S2 Slave Model Button | 15. Fuse |
| 7. Group/Channel Button | 16. Mounting Bracket |
| 8. BUZZ Button | 17. Umbrella Input |
| 9. Wireless Control Port | 18. Direction Adjusting Handle |

• LCD Panel

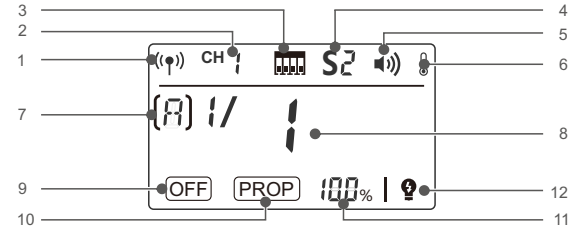

- | | |
|--|--|
| 1. Built-in 2.4G Wireless Transmission | 8. Flash Output |
| 2. Built-in Wireless Channel | 9. Modeling Lamp is off |
| 3. Built-in Wireless Channel Dial | 10. Modeling Lamp is in the PROP mode |
| 4. Slave Model Indicator | 11. Modeling Lamp shows the power in percentage |
| 5. Beep | 12. Modeling Lamp is off when triggering the flash |
| 6. Temperature Alarm Display | |
| 7. Built-in Wireless Group | |

• Accessories

1. Power Cord
2. Lamp Cover
3. Modeling Lamp
4. Instruction Manual



• Separately sold accessories

The product can be used in combination with the following accessories sold separately, so as to achieve best photography effects: X1, XT16 or FT-16 remote control, Power Inverter, Softbox, Photographic Umbrella, Light Stand, Barndoor, Snoot, etc.

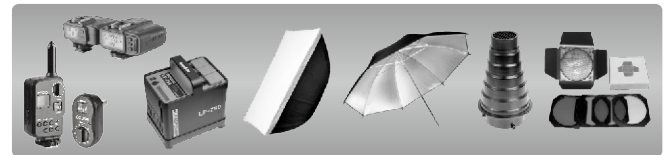

OPERATIONS

• Flash Preparation

1. Take down the lamp cover. Install the modeling lamp and put on the glass protection cover and the standard reflector.

(To uninstall the standard reflector, press the release button on the flash head and turn the standard reflector counter-clockwise to take it out, as illustrated in the picture.)



2. Attach the flash unit onto an appropriate light stand. Adjust the mounting bracket (16) for a good angle and make sure it is tightened and fixed. Use the direction adjusting handle (18) to adjust the flash to a desired direction. Umbrella input (17) is for different photo umbrellas to put in.

• Power Connection

Use the power cord to connect the flash to an AC power source and turn on the power switch (3).

• Modeling Lamp

Short press the Modeling Lamp Button (5) to choose the modeling lamp's mode (OFF, PROP and percentage); and long press the Modeling Lamp Button (5) to switch on or off the function that the modeling is off when triggering the flash.

Modeling lamp will be off automatically after lighting for 4 hours, avoiding overheat due to long-time lighting when the user is not nearby.

OFF: Modeling lamp is off.

PROP: The modeling lamp's power changes with the flash's power. The bigger power the flash has, the brighter the modeling lamp is.

Percentage: Adjust the modeling lamp's light brightness manually from 5% to 100%.

Setting:

1. When OFF is displayed, short press the <MOD/OFF> Button to enter PROP mode. Now the LCD panel shows PROP.
2. When PROP is displayed, short press the <MOD/OFF> Button to enter Percentage mode. Short press the SET Button and the percentage value is blinking. Turn the Select Dial to choose the light brightness from 5% to 100%. Short press the SET Button to exit.
3. When PROP is displayed, short press the <MOD/OFF> Button can back to <OFF> mode.
4. When in NON OFF mode, long press the <MOD/OFF> Button for 2 seconds to switch on the function that the modeling is off when triggering the flash. Now the LCD panel shows (🔒). Long press the <MOD/OFF> Button again to exit this mode.



When there is flammable accessory on the flash unit, do not keep the modeling lamp on for a long time. It is recommended to cool it down for one minute after 10 minutes' working.

• Power Output Control

Select dial (14) decides different power output, satisfying light requirements in different environment. The power is adjustable freely from 1/16 to 1/1 which will be accordingly shown on the LCD display (10). "--" on the display indicates that the flash triggering function is turned off. Press the Test button to discharge power when the flash output is adjusted from high to low.

• Test Button

To fire the flash without taking a picture, press the test button (4). It can also help adjust the flash brightness when combined with the select dial (14). Press the SET button and turn on the flash to view its version.

• Sync Triggering

The sync cord jack (2) is a $\Phi 3.5$ mm plug. Insert a trigger plug here and the flash will be fired synchronously with the camera shutter.

• GR/CH Button

Short press the GR/CH button can adjust the built-in wireless group. When the group indicator on the LCD panel is blinking, turn the select dial to change. And long press the GR/CH button can adjust the built-in wireless channel. When the channel indicator on the LCD panel is blinking, turn the select dial to change.

• Slave Trigger Model

Three slave triggering models are available and can be set by pressing slave model button (6).

◆No optical control: S1 or S2 is not displayed on the LCD panel, indicating the slave triggering function is shut down.

◆Optic S1 Secondary Unit Setting: In M manual flash mode, press <S1/S2> button so that this flash can function as an optic S1 secondary flash with optic sensor. With this function, the flash will fire synchronously when the main flash fires, the same effect as that by the use of radio triggers. This helps create multiple lighting effects.

◆Optic S2 Secondary Unit Setting: Press <S1/S2> button so that this flash can also function as an optic S2 secondary flash with optic sensor in M manual flash mode. This is useful when cameras have pre-flash function. With this function, the flash will ignore a single "pre-flash" from the main flash and will only fire in response to the second, actual flash from the main unit.

- **Buzz Function**

The sound button (8) is used for deciding whether there is sound reminder for ready flash after recharging. When the buzz indicator is on the LCD panel, the buzz function is working; when it is disappear, the buzz function is not working. A "B!" sound will be heard when it's fully charged.

- **Key Combination**

Synchronously press the GR/CH button and the S1/S2 button can turn on/off the built-in wireless transmission. If there are no wireless and channel indicators displayed on the LCD panel, the built-in wireless transmission is off. On the contrary, the built-in wireless transmission is on. Synchronously press the S1/S2 button and BUZZ button to recover factory settings.

- **Alarm Display**

- E0 The temperature sensor is not connected.
 - E1 When charging, the capacitance and voltage are not rising within 1 second.
 - E2 The fastest heating-up component is over the extra temperature.
 - E3 Discharged capacitance and voltage > rating +10%
- Alarm sounds, BIBI, ringing per 0.5 second. Press SET button to stop alarming.

- **Memory Function**

The device is equipped with memory function for the panel setting. It will help remember the panel setting 3 seconds after you set it. When starting up the flash next time, the panel setting will be the same as that before powering it off.

- **Wireless Control Function**

The flash unit has built-in 2.4G wireless transmission, which can be used together with X1 and XT16 flash trigger. Synchronously press the <GR/CH> Button and the <S1/S2> Button can turn on the built-in wireless transmission and the <(P)> is displayed. If there are other wireless flash systems nearby, you can change the channel IDs to prevent signal interference. The channel IDs of the master unit and the slave unit(s) must be set to the same.

Setting the Communication Channel

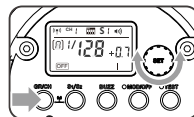

1 Long press the <GR/CH> Button for 2 seconds until the channel IDs is blinking.

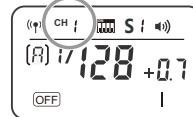

2 Turn the Select Dial to choose the channel from 1 to 32.

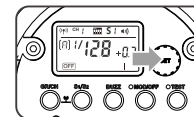

3 Press the <SET> Button to confirm.

Setting the Communication Group

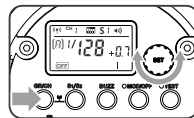

1 Short press the <GR/CH> Button for 2 seconds until the group IDs is blinking.

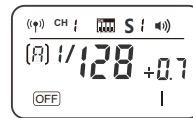

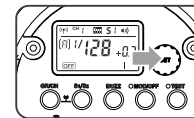

2 Turn the Select Dial to choose the group from 0 to F.

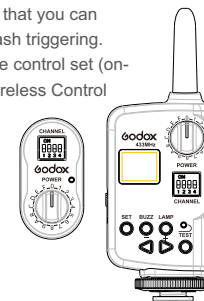

3 Press the <SET> Button to confirm.

The flash unit is built in with a Wireless Control Port so that you can wirelessly adjust the power level of the flash and the flash triggering. To control the flash wirelessly, you need a FT-16 remote control set (on-camera and on-flash). Insert its receive end into the Wireless Control Port on the flash and insert the transmit end into the camera hot shoe. Settings made on the hotshoe-mounted transmit and receive ends will be wirelessly communicated to the flash. Then you can press the camera shutter release button to trigger the flash. You can also hold the transmit end at hand to control your off-camera flash.



 For full instructions on the use of FT series remote control, see its user manual.

• Tube Replacement

Shut down the power and remove the power cord before replacing the flash tube. Wear insulated gloves to loosen the iron wire on the tube, keep a balanced hold on the two feet of the flash tube and pull out the old tube gently. Take down the feet casing from the old tube and put it on the new one. Hold two feet of the new tube, and target directly towards the two copper outlets, then push them slightly in. Twine the iron wire on the stainless steel sheet to fix the flash tube.



TECHNICAL DATA

Model	SK300II	SK400II
Max Power (Ws)	300Ws	400Ws
Guide Number(m ISO 100)	58	65
Color Temperature	5600±200k	
Operating Voltage	AC110V-120V~60Hz or AC220V-240V~50Hz	
Power Output Control	6.0~10.0(1/16~1/1)	
Modeling Lamp (W)	150W	
Modeling Lamp Level	5%~100%	
Recycle Time	0.1~1s	
Triggering Method	Sync cord, Test button, Slave triggering, Wireless control port	
Flash Duration	1/2000~1/800s	
Parameters output from the sync cord jack	5V	
Parameters output from the USB port	5V/200mA (only for Godox receiver)	
Fuse	AC220V-240V~50Hz: 5A AC110V-120V~60Hz: 8A	
Dimension	Flash diameterΦ12.7cm, height of flash with handle 20.6cm length of flash with lamp cover 34cm	Flash diameterΦ12.7cm, height of flash with handle 23.2cm length of flash with lamp cover 38cm
Net Weight	Approx. 1.9kg	Approx.2.1kg

MAINTENANCE

- Shut down the device immediately when it works abnormally and find out the reason.
- Avoid sudden impacts and the lamp should be dedusted regularly.
- It is normal for the lamp to be warm when in use. Avoid continuous flashes if unnecessary.
- Maintenance of the flash must be performed by our authorized maintenance department which can provide original accessories. The flash-tube and the modeling lamp are user-replaceable. Replacement tubes and lamps can be obtained from the manufacturer.
- This product, except consumables e.g. flash tube and modeling lamp, is supported with a one-year warranty.
- Unauthorized service will void the warranty.
- If the product had failures or was wetted, do not use it until it is repaired by professional.
- Disconnect the power when cleaning the flash or when changing the flashtube / modeling lamp.
- Changes made to the specifications or designs may not be reflected in this manual.