

Godox

高速同步闪光LED灯

High Speed Sync Flash LED Light

FV150 / FV200



深圳市神牛摄影器材有限公司
GODOX Photo Equipment Co., Ltd.

地址/Add: 深圳市宝安区福海街道塘尾社区耀川工业区厂房2栋
Building 2, Yaochuan Industrial Zone, Tangwei Community, Fuhai Street, Bao'an District, Shenzhen, China
电话/Tel: +86-755-29609320(8062) 传真/Fax: +86-755-25723423
邮箱/E-mail: godox@godox.com http://www.godox.com
705-FV1500-03 Made In China



说明手册
Instruction Manual

前言

感谢您购买神牛产品！

高速同步闪光LED灯FV系列在传统LED灯的基础上增加了闪光功能，既可作为LED灯使用，又可作为闪光灯使用。功率强劲，功能强大，设有8种特效模式打造更多创意拍摄，适用范围广泛。

主要特点：

- 一灯两用，既可作为LED灯使用，又可作为闪光灯使用
 闪光时的亮度为常亮灯亮度的四倍，更好凝固动作瞬间
- 闪光模式时支持1/8000秒高速同步
- 1/2功率时，可实现连续闪光1秒10张以上，高速同步可实现1秒8张
- 内置神牛2.4G无线X系统，可兼容各品牌相机
- LED灯模式光源稳定，0%-100%精确调节亮度
- 8种FX特效模式，模拟各种拍摄场景，轻松实现创意光效
- 16组32频道分组遥控
- U型支架设计，可吊装，方便调节各种亮度
- 保荣卡口，支持安装各类光效附件
- LCD屏清晰显示
- 良好的散热性能

警告

- ⚠ 请保持干燥：请勿用湿手接触产品，亦不可将产品浸入水中或暴露于雨中。
- ⚠ 请勿私自拆卸产品，如产品出现故障须由本公司或授权的维修人员进行检查维修。
- ⚠ 请勿让儿童接触本产品。
- ⚠ 本产品不能防水，在雨天及潮湿环境下请注意防水。
- ⚠ 请勿放置在超过40摄氏度的高温环境中。
- ⚠ 请勿在化学品、可燃性气体或其他特殊物质附近使用闪光灯，这些物质在特殊情况下可能对闪光灯发出的瞬间强光敏感，有可能导致火灾或电磁干扰。在这些场合下，请注意相关警告标识。

部件名称

灯体

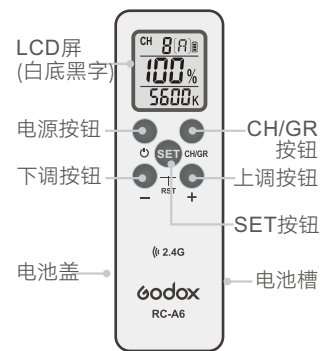
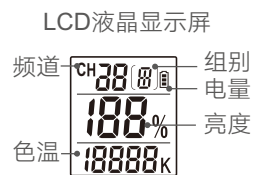
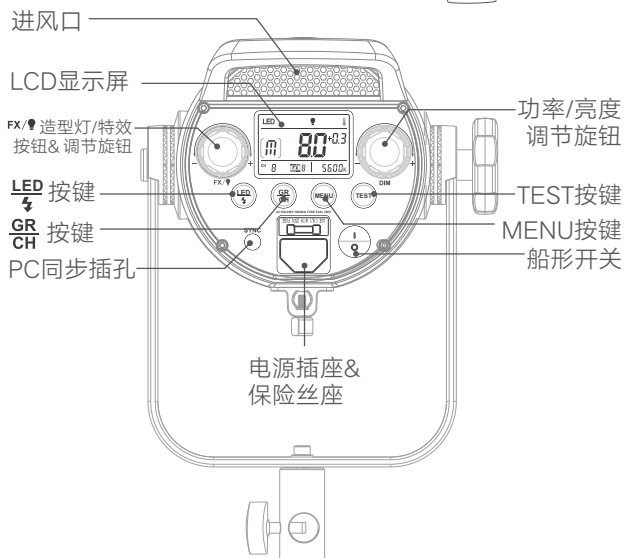
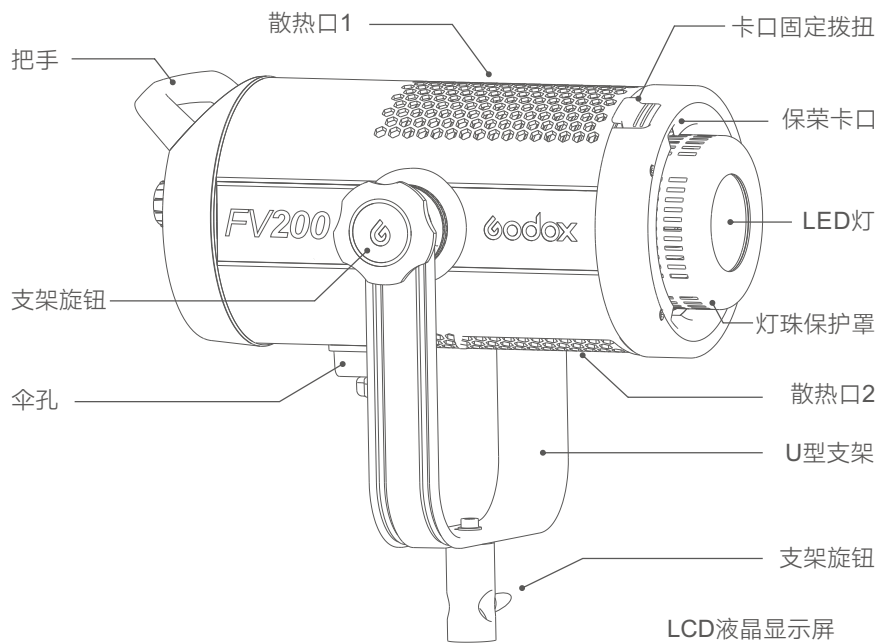

部件名称

LCD液晶显示屏

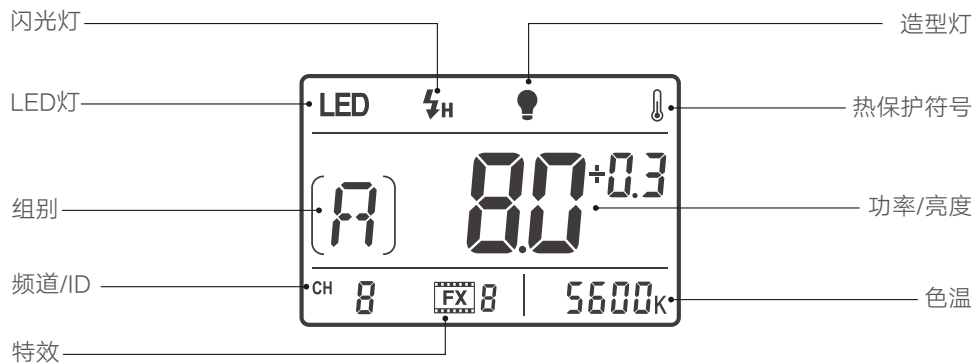

标配物品

- 1、灯体
- 2、RC-A6遥控器
- 3、电源线
- 4、LED保荣反光罩
- 5、灯头保护罩



可选购附件

可搭配本公司以下摄影附件使用，以获得最佳的拍摄效果和使用体验：
Xpro、X2、XT32及其他带X系统发射功能的引闪器、逆变器、柔光箱、反光伞、灯架、蜂巢、雷达罩、束光筒等。



接通电源

通过电源线接通交流电源与闪光灯，拨动闪光灯上的电源开关至ON，即可开机。

操作说明

一、闪光灯设置

LED按钮

此按钮为LED模式和闪光灯模式选择按钮。短按可切换模式，显示LED为LED模式，显示⚡为闪光模式。

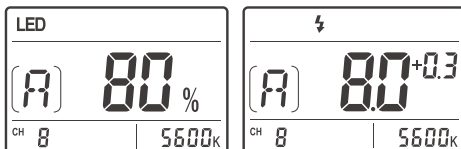

LED模式

闪光模式

功率调节

在闪光灯模式下，闪光功率通过功率/亮度调节旋钮控制，可以从“1/16”至“1/1”或“6.0”至“10”自由调节，LCD显示屏将对所选择功率作准确显示。LCD显示屏显示“OF”时，表示闪光引闪功能关闭。从高档调节至低档，需要按下试闪按钮来放电以获得所需的功率。

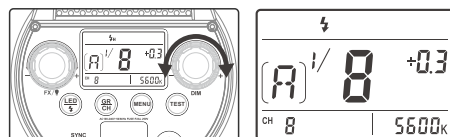

亮度调节

在LED模式下，LED亮度通过功率/亮度调节旋钮控制，亮度调节范围0%-100%，LCD显示屏将准确显示所设置的亮度。

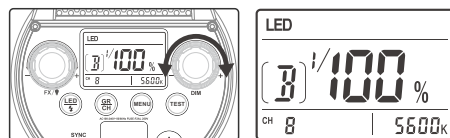

TEST按钮

欲使闪光灯测试闪光而不拍照，请按试闪按钮。可以通过试闪按钮结合功率/亮度调节旋钮来调节闪光输出功率和亮度。按住功率/亮度调节键并开机，可查看闪光灯的版本号及恢复出厂设置。

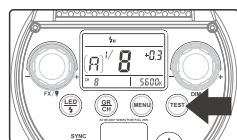

MENU按钮

按MENU按钮，进入自定义功能区。

自定义功能符号	功能	设置符号	设置和说明	使用范围限制
F1	无线ID	OF	关闭ID	无
		01 ~ 99	可选择01 ~ 99任意一个数字	
F2	输出功率显示模式	1/P	显示功率方式为分数形式	闪光模式
		P.P	显示功率方式为小数形式	

GR/CH按钮

短按GR/CH按钮可以通过内置无线调节组别，LCD组别显示在闪烁时，旋转调节旋钮可以设置组别。长按GR/CH按钮可以调节内置无线频道，LCD频道显示在闪烁时，旋转调节旋钮可以设置频道。

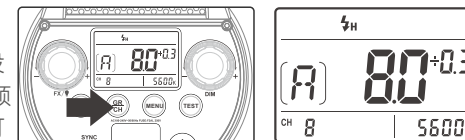

造型灯/特效按钮

造型灯开关：

在闪光灯模式下，按FX/☹按钮，造型灯打开或关闭。造型灯打开时，旋转FX/☹旋钮调整造型灯亮度，造型灯亮度调节范围5%-100%。

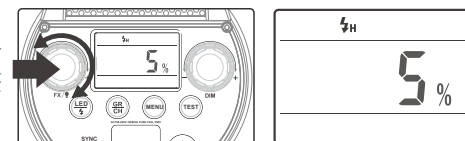

特效开关：

在LED灯模式下，按FX/☹按钮，特效打开或关闭。旋转FX/☹旋钮选择特效模式，有8种特效模式可选。

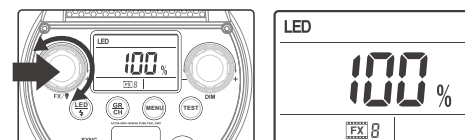

二、闪光模式：

2.4G无线控制：

FV系列产品使用闪光模式时具备无线2.4G接收功能，可选购神牛带无线发射功能的X系统产品，如X1、X2、Xpro系列、XT32等，此类带发射功能的产品可远程调节FV系列产品功率，控制造型灯的开关及触发闪光灯引闪。



同步孔触发：

FV系列产品带PC同步插孔，同步插孔规格为3.5mm，此处可插入同步线或者触发器(如RT、DM等)触发插头对闪光灯进行同步引闪。



三、LED灯模式无线控制

FV系列可闪光LED灯具备无线遥控功能，使用2.4G无线技术，可同时分别控制16个LED灯。32个频道，100个无线ID，抗干扰强。

注：使用前请把闪光灯和RC-A6遥控器的频道与组别调至一致。

遥控器频道/组别调整

- 在常态时，按CH/GR按钮，此时组别闪烁，按“-”“+”按钮可选择组别(A~F，0~9)。
- 在常态时，按CH/GR按钮2次，此时频道闪烁，按“-”“+”按钮可选择频道(1~32)。

遥控器ID调整

- 在常态时，双击CH/GR按钮，按“-”“+”按钮可选择ID号（ID号为OFF,0-99）。

遥控器亮度参数调节

- 在常态时，按“-”“+”按钮可对亮度调整。

遥控器色温参数调节

- 在常态时，按SET按钮，此时色温值闪烁，按“-”“+”按钮可对色温调整。

遥控器复位：同时按住“-”“+”按钮即可复位。

色温调节范围设定：

出厂时遥控器的色温调节范围为2500-10000K。

为方便客户使用遥控器还设置了色温调节范围设定功能：在关机状态下按住SET按钮开机进入色温调节界面，按CH/GR按钮切换最低色温和最高色温设置，按“-”、“+”按钮选择色温值，按SET键确定选择的色温。

注：控制器在开机状态下才可以接收无线信号。

四、LED特效模式

LED灯模式时，灯可设置8种FX特效模式，模拟各种拍摄场景，轻松实现创意光效。

显示	FX1	FX2	FX3	FX4	FX5	FX6	FX7	FX8
场景	Flash1	Flash2	Flash3	Storm1	Storm2	Storm3	TV	坏灯泡

⚠ 神牛2.4G无线漏闪的原因及解决办法:

1、外部环境2.4G信号干扰(如无线基站、2.4G wifi路由、蓝牙设备等)

→请调节引闪器的频道CH设置(建议+10)，找到无干扰的频道来工作，或者在工作时关闭其他2.4G设备。

2、请确认闪光灯是否已经回电或者回电速度是否已经跟上连拍速度(闪光灯就绪指示灯已经亮起)，并且没有处于过热保护或者其他异常状态中

→请下调闪光灯功率的档位，如是TTL模式请尝试改为M模式(TTL模式下需要预闪一次)。

3、是否引闪器和闪光灯距离太近(距离<0.5m)

→请在引闪器上打开“近距离无线模式”：

X1、X2、XPro系列：按住引闪按钮不放，然后开机，直至指示灯闪2次。

Xpro系列：设置C.Fn-DIST为0-30m。

4、是否引闪器和接收端设备在低电状态

→请更换电池(引闪器电池建议使用1.5V一次性碱性电池)。

产品参数

可闪光LED灯	FV150	FV200
供电	AC100V-240V(50/60HZ)	
功率	150W	200W
色温	5600 ± 200K	
100%光照度(LUX, 1米距离)	≈58000	≈74000
CRI ≈	96	
TLCI ≈	97	
常亮模式调光范围	0%-100%	
工作环境温度	-10°C ~ 40°C	
闪光模式功率输出	1/16-1/1 或6.0-10.0	
频道	32个	
组别	16组(A、B、C、D、E、F, 0-9)	
产品尺寸(不含反光罩)	34x20x16cm	36.7x20x16cm
净重	3.13Kg	3.24Kg

遥控器	RC-A6
供电	3.0V(AAA*2)(不包含)
无线频率	2.4GHz
距离(空旷)	50米
频道	32个
分组遥控	16组(A-F, 0-9)
待机时间	1年以上
工作环境温度	-10°C~40°C
产品尺寸	120*38*15mm
净重	30g

*设计和规格如有变更，恕不另行通知。

Foreword

Thank you for purchasing this Godox Product!

Flash Video Light FV series add flash functions based on the traditional LED light. FV series can be served as a flash, as well as an LED light. With strong power, abundant functions and 8 special effects modes, it can achieve creative shooting easily.

Main Features:

- Can both serve as a flash and an LED light.
- The light brightness of the flash is four times of LED light's, which increases the freezing ability of instantaneous action.
- Supports 1/8000s high-speed sync function when being used as flash.
- Over 10 continuous flashes per second and 8 continuous flashes per second in high-speed sync mode in 1/2 power output.
- Built-in Godox 2.4G wireless X system, compatible with cameras of multiple brands.
- With stable light source and 0% to 100% precise light adjustment when being used as LED light.
- With 8 FX special effects mode to simulate various of shooting scene.
- With 16 groups and 32 channels wireless control.
- With U-type bracket to adjust different angles easily.
- Bowens-mount enables to install various of accessories.
- Clear LCD display.
- Excellent heat dissipation.

Warning

- ▲ Always keep this product dry. Do not use in rain or in damp conditions.
- ▲ Do not disassemble. Should repairs become necessary, this product must be sent to an authorized maintenance center.
- ▲ Keep out of reach of children.
- ▲ As this product do not have waterproof function, please take measures of waterproof in rainy or damp environment.
- ▲ Do not use the flash unit in the presence of flammable gases, chemicals and other similar materials. In certain circumstance, these materials may be sensitive to the strong light emitting from this flash unit and fire or electromagnetic interference may result.
- ▲ As this product has built-in lithium battery, do not disassemble, impact, squeeze or put it into fire. If serious bulge occurs, please do not use. Do not use or store the product if the ambient temperature reads over 40°C. Please charge the product with specialized charger and correctly operate it within the defined voltage and working temperate according to the instruction manual.

Body

Main Body

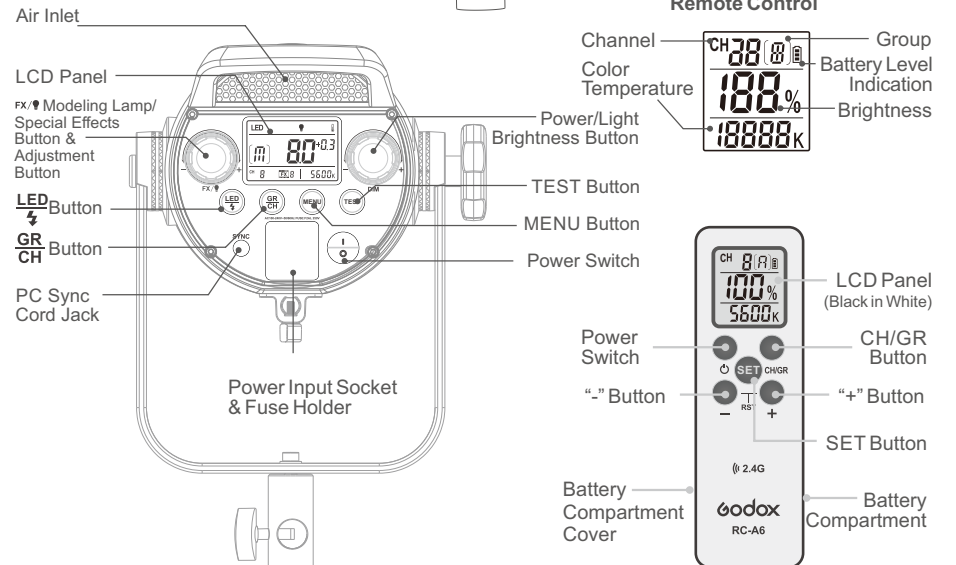
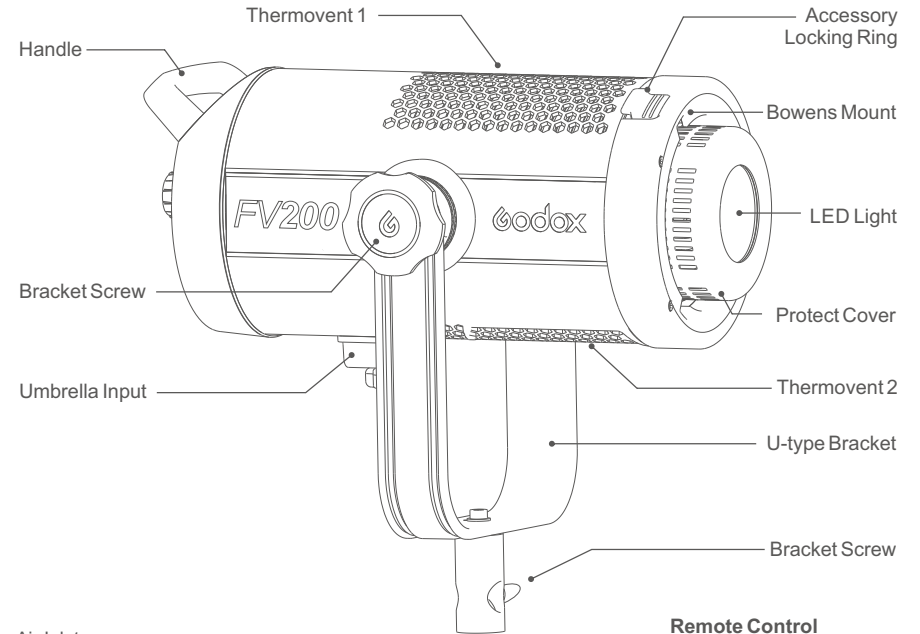

LCD Panel

LCD Panel

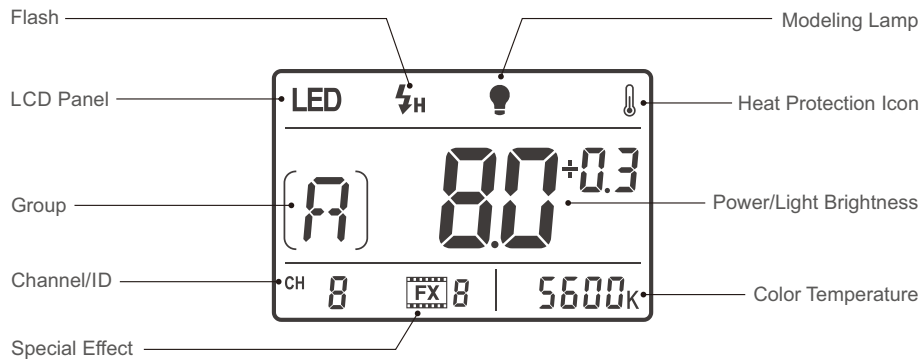

Included Items

1. Flash video light
2. RC-A6 Remote control
3. Power cord
4. Reflector for Bowens mount LED light
5. Lamp cover



Separately Sold Accessories

The product can be used in combination with the following accessories sold separately, so as to achieve best photography effects: XPro, X2 or XT32 remote control, Power Inverter, Softbox, Photographic Umbrella, Light Stand, Barndoor, Snoot, etc.



Power Connection

Use the power cord to connect the flash to an AC power source and turn on the power switch.

Operation

Flash Setting

LED Button

This button can be pressed to switch LED mode or flash mode. Short press the button and LED will be displayed, which means the light can be used as an LED. When is displayed, the light can be used as a flash.

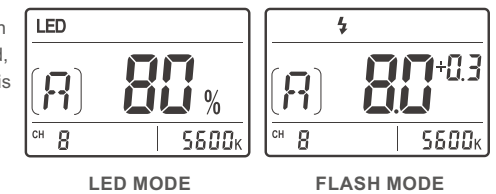

Power Adjustment

In flash mode, the flash power can be adjusted by light brightness adjustment button from 1/16 to 1/1 or 6.0 to 10. And the power output will be clearly displayed on the LCD Panel. "OF" on the display indicates that the flash triggering function is turned off. Press the Test button to discharge power when the flash output is adjusted from high to low.

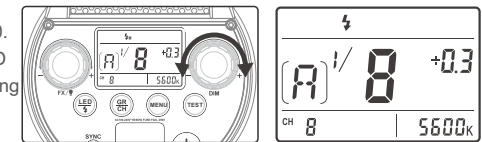

Light Brightness Adjustment

In LED mode, the light brightness of LED light can be adjusted by light brightness adjustment button from 0% to 100%. And the light brightness will be clearly displayed on the LCD Panel.

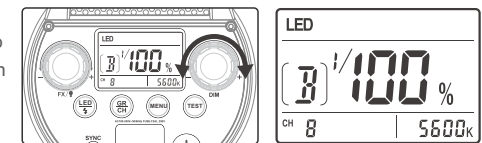

Test Button

To fire the flash without taking a picture, press the test button. It can also help adjust the flash output and light brightness when combined with the light brightness adjustment button. Hold down the light brightness and turn on the light, the version will be displayed on the LCD panel and this operation can also be used to restore factory setting.

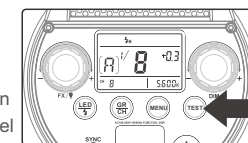

MENU Button

Press the Menu button to enter custom setting area.

Custom Function Setting

Custom Function Signs	Functions	Setting Signs	Settings & Descriptions	Restrictions
F1	Wireless ID	OF	Off ID	No
		01~99	Choose any figure from 01~99	
F2	Power output display mode	1/P	Display power in the form of fractions	Flash mode
		P.P	Display power in the form of fraction decimal	

GR/CH Button

Short press the GR/CH button can adjust the wireless groups. When the group icon on the LCD panel is blinking, turn the light brightness adjustment button to set the groups. Long press the GR/CH button to adjust the wireless channels. When the channel icon on the LCD panel is blinking, turn the light brightness adjustment button to set the channels.

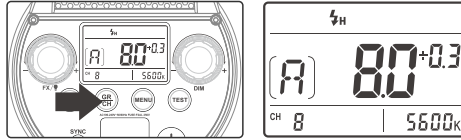

Modeling Lamp/Special Effect Button

Modeling lamp ON/OFF: In flash mode, press the modeling lamp/special effects button to turn on or off the modeling lamp. When modeling lamp is on, turn the modeling lamp/special effects button to adjust the light brightness of modeling lamp from 5% to 100%.

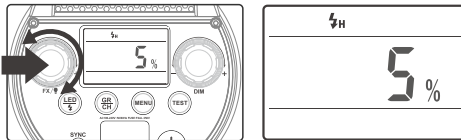

Special Effects ON/OFF: In LED mode, press the modeling lamp/special effects button, and the special effects will be on or off. Turn the modeling lamp/special effects button to choose from the eight special modes.

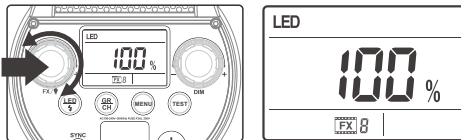

Flash Mode

2.4G Wireless control

In flash mode, FV series has 2.4G wireless receiving functions. Purchase Godox X series flash trigger e.g. X1, X2, XPro series and XT 32 flash trigger to wirelessly control FV series' power, modeling lamp's on/off and triggering.



Sync Triggering

The sync cord jack is a $\Phi 3.5\text{mm}$ plug. Insert a trigger plug here and the flash will be fired synchronously with the camera shutter.



Wireless Control in LED Mode

With 2.4G wireless system, FV series have remote grouping and control function. Up to 16 groups of LED lights can be controlled. 32 channels and 100 wireless IDs are available with strong anti-interference capability. Please set the channels and groups of LED light to the same as those of RC-A6 remote control before usage.

Adjusting Channel/Group with the Remote Control

- Press the CH/GR button and the group icon blinks. Press the "-" "+" button to choose a group (A to F, 0 to 9).
- Press the CH/GR button twice and the channel icon blinks. Press the "-" "+" button to choose a channel (1 to 32).

Adjusting ID with the Remote Control

- Double click the CH/GR button and press the "-" "+" button to choose ID from OFF or 0 to 99.

Adjusting Light Brightness with the Remote Control

- Press the "-" "+" button to adjust the light brightness.

Adjusting Color Temperature with the Remote Control

- Press the SET button of the remote control and the color temperature icon blinks. Press the "-" "+" button to adjust the color temperature.

Remote control reset: press down "-" and "+" button simultaneously to reset.

Note: The wireless signal can be received only when the controller of LED light is powered on.

Setting color temperature range

The factory setting of remote control's color temperature range is 2500-10000K.

In order to use remote control conveniently, color temperature range settings are added: when the remote control is off, hold down the SET button and turn it on to enter color temperature adjusting interface. Press CH/GR button to switch the lowest and highest color temperature value and press "-" or "+" button to change the value. Press the SET button to confirm it.

LED Special Effects Mode

In LED mode, 8 FX special effects mode can be set to simulate various of shooting scene and achieve creative shooting.

Display	FX1	FX2	FX3	FX4	FX5	FX6	FX7	FX8
Scene	Flash1	Flash2	Flash3	Storm1	Storm2	Storm3	TV	Broken bulb

⚠ The Reason & Solution of Not Triggering in Godox 2.4G Wireless

- 1. Disturbed by the 2.4G signal in outer environment (e.g. wireless base station, 2.4G wifi router, Bluetooth, etc.)**
→ To adjust the channel CH setting on the flash trigger (add 10+ channels) and use the channel which is not disturbed. Or turn off the other 2.4G equipment in working.
- 2. Please make sure that whether the flash has finished its recycle or caught up with the continuous shooting speed or not (the flash ready indicator is lighten) and the flash is not under the state of over-heat protection or other abnormal situation.**
→ Please downgrade the flash power output. If the flash is in TTL mode, please try to change it to M mode (a preflash is needed in TTL mode).
- 3. Whether the distance between the flash trigger and the flash is too close or not**
→ Please turn on the "close distance wireless mode" on the flash trigger (< 0.5m):
X1, X2 and XPro series: press the test button and hold on, then turning it on until the flash ready indicator blinks for 2 times.
XPro series: Set the C.Fn-DIST to 0-30m.
- 4. Whether the flash trigger and the receiver end equipment are in the low battery states or not**
→ Please replace the battery (the flash trigger is recommended to use 1.5V disposable alkaline battery).

Technical Data

Flash Video Light	FV150	FV200
Power Supply	AC100V-240V (50/60Hz)	
Power	150W	200W
Color Temperature	5600±200K	
100% Light Brightness(LUX,1M)	≈58000	≈74000
CRI ≈	96	
TLCI ≈	97	
Light Brightness Range	10%-100%	
Operation Temperature	-10°C ~ 40°C	
Power Output	1/16-1/1 or 6.0-10.0	
Channel	32	
Group	16(A, B, C, D, E, F, 0-9)	
Dimension (not included a standard reflector)	34x20x16cm	36.7x20x16cm
Net Weight	3.13Kg	3.24Kg

Remote Control	RC-A6
Power Supply	3.0V(AAA*2)(not include)
Wireless Frequency	2.4GHz
Distance (emptiness)	50m
Channel	32
Group	16 groups(A-F, 0-9)
Standby Time	Over one year
Operation Temperature	-10°C ~ 40°C
Dimension	120*38*15mm
Net Weight	30g

FCC Warning

This device complies with part 15 of the FCC Rules. Operation is subject to the following two conditions: (1) This device may not cause harmful interference, and (2) this device must accept any interference received, including interference that may cause undesired operation.

Any Changes or modifications not expressly approved by the party responsible for compliance could void the user's authority to operate the equipment.

Note: This equipment has been tested and found to comply with the limits for a Class B digital device, pursuant to part 15 of the FCC Rules. These limits are designed to provide reasonable protection against harmful interference in a residential installation. This equipment generates uses and can radiate radio frequency energy and, if not installed and used in accordance with the instructions, may cause harmful interference to radio communications. However, there is no guarantee that interference will not occur in a particular installation. If this equipment does cause harmful interference to radio or television reception, which can be determined by turning the equipment off and on, the user is encouraged to try to correct the interference by one or more of the following measures:

- Reorient or relocate the receiving antenna.
- Increase the separation between the equipment and receiver.
- Connect the equipment into an outlet on a circuit different from that to which the receiver is connected.
- Consult the dealer or an experienced radio/TV technician for help.

***RF warning:**

This equipment complies with FCC radiation exposure limits set forth for an uncontrolled environment. This equipment should be installed and operated with minimum distance 20cm between the radiator & your body.