

705-ES45K0-00

Godox

电竞主播灯  
E-sports LED Light

ES45

KIT

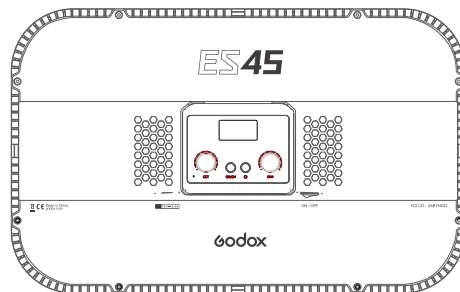

深圳市神牛摄影器材有限公司

地址: 深圳市宝安区福海街道塘尾社区福川工业区厂房2栋  
电话: 0755-29609320(8062) 传真: 0755-25723423 邮箱: godox@godox.com

GODOX Photo Equipment Co., Ltd.

Add: Building 2, Yaochuan Industrial Zone, Tangwei Community, Fuhai Street, Bao'an District,  
Shenzhen, China Tel: +86-755-29609320(8062) Fax: +86-755-25723423 E-mail: godox@godox.com

godox.com

Made in China



说明手册  
Instruction Manual

## 前言

感谢您购买神牛产品！

ES45 Kit电竞主播灯可自由调节亮度和色温，支持手机APP和2.4G无线远程遥控，适用于电竞、吃播、美妆等主播在直播或录制短视频过程中实现补光作用。外观超薄，操作便捷，轻巧便携。

产品有以下亮点：

- 176颗优质灯珠，配合一体式柔光平面灯板，光效柔和不刺眼
- 可无线调节精确各组亮度（0%-100%）或色温（2800K-6500K）
- 内置锂电池，持续使用时间长达约22个小时
- 可拆卸操控面板操作便捷，磁吸式供电
- 内置无线2.4G或手机APP远程遥控，抗干扰强
- OLED单色屏，参数设置自动保存
- 简约时尚，适配桌面使用

## ⚠ 警告

- ⚠ 请勿将摄影灯放置在高温、高湿的地方。
- ⚠ 此机有温度保护功能，当温度过高时进入保护状态，当温度降低后恢复正常。
- ⚠ 请勿用湿手接触产品，亦不可将产品浸入水中或暴露于雨中。

## 部件名称

### • 主机

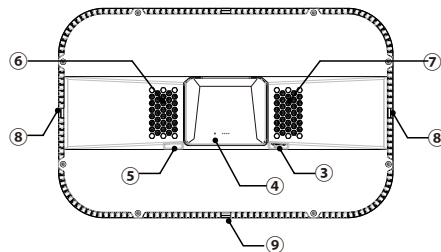
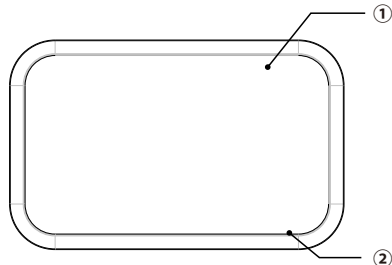

- |             |            |
|-------------|------------|
| 01. 176粒灯珠  | 06. 散热口1   |
| 02. 柔光板     | 07. 散热口2   |
| 03. 开关键     | 08. 支架安装孔1 |
| 04. 指示灯     | 09. 支架安装孔2 |
| 05. Dc电源插座孔 |            |

## • 操控面板

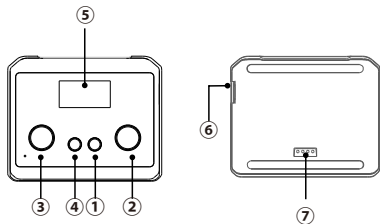

- 01. 电源开关按键
- 02. DIM亮度调节旋钮
- 03. CCT色温调节旋钮
- 04. GR/CH按钮
- 05. OLED显示屏(蓝底白字)
- 06. Type-C USB接口(仅用于充电)

## 标配物品

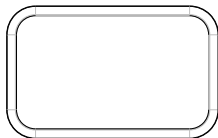

灯体 \*1



可拆卸操控面板 \*1

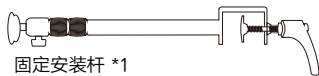

固定安装杆 \*1



电源线 \*1



电源适配器 \*1



说明书 \*1

## 电源管理

### 1. 主机供电方式

DC适配器供电：

输入：100~240V 50/60Hz 1.3A，

输出：14V / 3.42A。

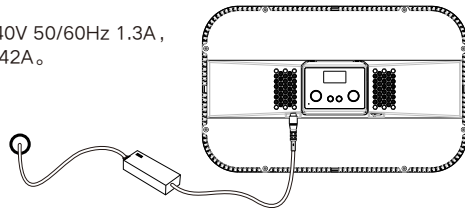

注：

\*接通直流电流，操控面板电量显示充电状态或满格状态。

\*必须使用神牛标配的适配器，否则测试出来的参数不一致。

### 2. 操控面板

操作面板有两种充电方式：

第一种：主机供电时，将操控面板放置在主机上，可进行充电。

第二种：将操控面板从主机拆下，用Type-C USB线进行充电。

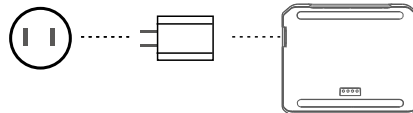

# 操作说明

## 1. 开始使用主播灯

1.1 DC口插入适配器。

1.2 按开关键开机，主播灯点亮。

1.3 指示灯：

蓝灯常亮，当组别与发射端一致，且接收到发射端信号时红灯闪。

1.4 按操控面板电源开关键，短按实现开机/关机功能。

1.5 开机后OLED显示主机当前界面。

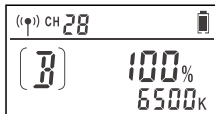

## 亮度调节

在常态时，旋转操控面板上的旋钮DIM可对亮度进行调节，左减右加，亮度范围0%~100%；单元值为1，快速调节10个单元值。

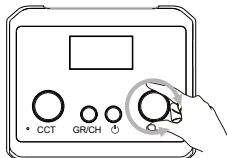

## 色温调节

在常态时，旋转操控面板上的旋钮CCT可对色温调节，左减右加，色温范围2800K~6500K；单元值为100，快速调节500个单元值。

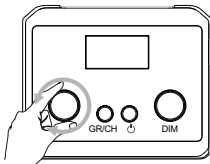

# 无线模式控制选择

1. 可拆卸操控面板具备2.4G无线遥控功能，先将操控面板放置LED灯上设置好频道(CH)与组别(GR)后，可取下操控面板调节亮度、色温等功能。

注：出厂时操控面板与LED灯的频道和组别已配对好，无需重新设置。

主机在上电状态下才可以接收无线信号。

多个操控面板也可以同时使用，主机上的面板通道，组别与拆卸面板设置一致，方可控制多台LED灯参数调节。

## CH频道/GR组别调节

1.CH频道调节：

在常态时，短按GR/CH按键一次，此时选中频道，旋转调节旋钮CCT可选择频道调节(1~32)。

2. GR组别调节：

在常态时，短按GR/CH按键两次，此时选中组别，旋转调节旋钮CCT可选择组别调节(A/B/C)。

3. 短按GR/CH按键三次，退出无线频道和组别的调节。

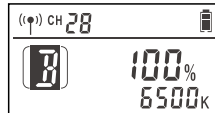
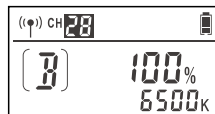

注：在选中频道或组别后10秒无任何操作，自动退出无线频道或组别的调节。

2. 可拆卸操控面板具备手机APP蓝牙无线控制功能，可同时多台连接蓝牙使用，抗干扰强。

## 蓝牙连接

1. 直接扫二维码即可下载“Godox Light”手机APP(安卓和苹果系统都可以使用)。
2. 接通电源开机后打开手机APP进行配对或组网。具体操作请参考手机APP“帮助”手册，里面有详情教程。



注：

查看MAC码和蓝牙密码重置一定要在操控面板和主机开机且已连接的状态下操作。

1. 查看MAC码：在操控面板和主机开机并连接状态下，长按GR/CH键2秒，进入蓝牙界面，显示屏左上方显示蓝牙MAC码。

2. 蓝牙密码重置：在蓝牙MAC码界面，旋转CCT旋钮选择Yes，再短按一次GR/CH键，屏幕上蓝牙符号闪烁表示密码在重置。旋转CCT旋钮选择，短按一次GR/CH键，返回主界面。



## 产品参数

型号	ES45 Kit
DC适配器供电	输入: 100~240V 50/60Hz 1.3A 输出: 14V / 3.42A
操控面板锂电池供电	3.7V锂电池(内置)
功率	最大约56W(色温4100K)
频道	32个(1~32)
组别	3组(A, B, C)
色温范围	2800 ~ 6500K
100%光通量(lm)	最大2500
100%光照度(lx)(暗室, 0.5米距离)	最大≈4100
CRI	≥96
TLCI	≥97
调光范围	0~100%
控制方式	手机APP/2.4G无线
灯珠数量	176粒
工作环境温度	-10~40℃
产品尺寸	367*230*31.04mm(不含操控面板) 367*230*45.9mm(含操控面板)
净重	≈1.33KG(含操控面板)

\* 设计和规格如有变更，恕不另行通知。

## 待机功能

1. 操控面板在脱离主机并无操作一分钟后的屏幕会自动变暗。
2. 操控面板在脱离主机并无操作一小时后会自动关机。

## 维护保养

- 为了防止灰尘的堆积影响到产品的性能，请定时用干净的湿布轻轻擦拭产品外部。
- 为防止灰尘的堆积影响到产品的性能，请定时用干净的湿布轻轻擦拭产品外部。
- 所有维修概由本厂指定可供原厂配件之维修部负责。
- 1年保修，电源适配器、电源线等配件不在此保修范围内。
- 经发现，擅自检修此主播灯的，将取消主播灯之一年保修期，维修需要收取相关费用。
- 本品如出现故障或者被水淋湿，在专业人员维修后方可继续使用。

本设备包含型号核准代码为：CMIIT ID:2020DP13510，为该产品的无线电发射模块。

## Foreword

Thank you for purchasing Godox product!

E-sports LED Light ES45 Kit supports free brightness and color temperature adjustment, 2.4G wireless and smartphone APP control. It provides lighting for electronic sports, livestream, make up and video recording with compact body, easy operation and great portability.

### Main Features

- 176 premium LED bulbs with all-in-one light board, offering soft light without blinding the eyes
- Freely adjust each group's brightness(0%-100%) or color temperature(2800K-6500K)
- Built-in lithium battery whose duration up to approx. 22 hours
- Can be easily controlled via detachable control panel
- Support 2.4G wireless or smartphone APP control
- OLED panel and parameters auto saved
- Simple, stylish and suitable for using on the table

### Warning

- △ Always keep this product dry. Do not put it in high-temperature or in damp conditions.
- △ Built-in over-temperature protection functions, this product will enter protection status when the temperature is too high and back to normal after the temperature decreased.
- △ Do not touch the product with wet hands. As this product do not have waterproof function, please take measures of waterproof in rainy or damp environment.

## Names of Parts

### • Main Body

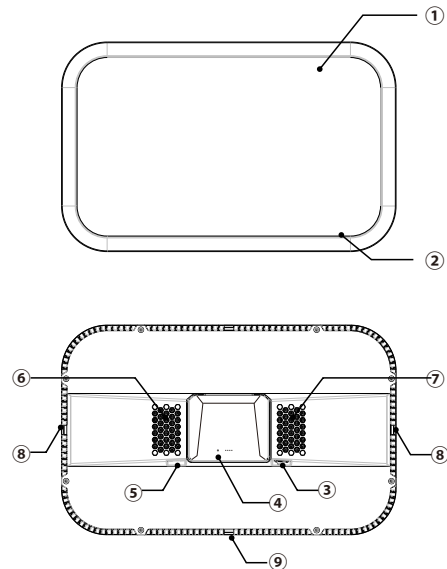

- |                     |                             |
|---------------------|-----------------------------|
| 01. 176 LED beads   | 05. DC Power Socket         |
| 02. light board     | 06. Thermovent 1            |
| 03. Power Switch    | 07. Thermovent 2            |
| 04. Indicator       | 08. Bracket Mounting Hole 1 |
| 05. DC Power Socket | 09. Bracket Mounting Hole 2 |

## • Function Operate Panel

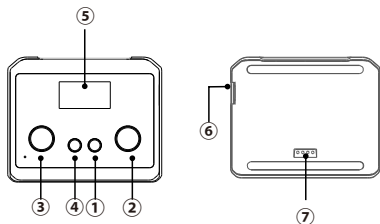

- 01. Power Switch
- 02. DIM Brightness Select Dial
- 03. CCT Color Temperature Select Dial
- 04. GR/CH Button
- 06. OLED Display (white in blue)
- 07. Type-C USB Port (only for charging)

## What's in the Box

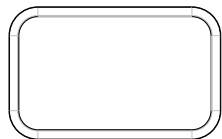

Light Body \*1



Detachable Panel \*1

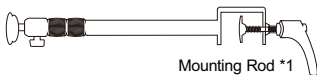

Mounting Rod \*1



Power Cable \*1



Adapter \*1



Instruction Manual \*1

## Battery Management

### 1. Power Supply of Main Body

DC Power supply by adapter:  
input: 100~240V 50/60Hz 1.3A,  
output: 14V 3.42A.

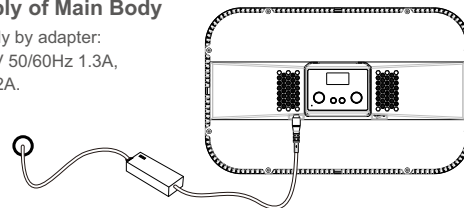

Note:

- \* When connected to DC power, the control panel's battery power will be displayed in full level.
- \* The included Godox adapter must be applied, otherwise, the tested parameters may not keep to the same.

### 2. Power Supply of Operate Panel

There are two methods to supply power for operate panel.

1. When the main body is being charged, install the operate panel onto the main body to get power.
2. Detach the operate panel from the main body. Then, charge the panel through Type-C USB cable.

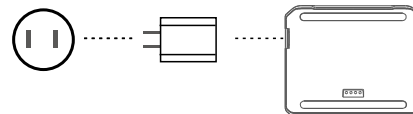

# Operation

## 1. Using the Light

- Insert the adapter into DC port.
- Press the O- power switch to power it on, and the LED light will be lighted on.  
When the blue light is always lighting the light's group is set to the same as the transmitter's and has already received the transmitter's signal, the indicator will be blinking in red.
- Short press the power switch of operate panel to power it on or off.
- The OLED panel will display the current information after being powered on.

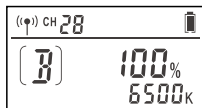

## Brightness Adjustment

In normal status, turn the DIM select dial leftwards to decrease the brightness value while rightwards to increase. The light brightness can be adjusted from 0% to 100%. And the adjusted value is 1 in common adjustment and changes to 10 in quick adjustment.

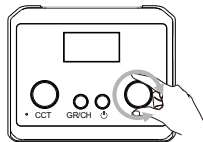

## Color Temperature Adjustment

In normal status, turn the CCT select dial leftwards to decrease the color temperature value while rightwards to increase. The color temperature can be adjusted from 2800K to 6500K. And the adjusted value is 100 in common adjustment and changes to 500 in quick adjustment.

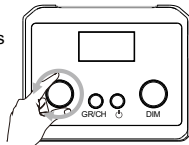

# Wireless Modes Selection

1. The detachable operate panel processes 2.4G wireless remote functions.  
Please put the operate panel onto the LED light and set the channel (CH) and group (GR) parameters. Then, detach the operate panel to adjust brightness, color temperature and other functions.

Note:

- The channels and groups of operate panel and LED light have been already matched by default. There is no need for resetting.
- The main body can only receive wireless signals after being powered.
- Several operate panel can be applied simultaneously. Set the channels and groups to the same as operate panel's to control the parameters of multiple LED lights.

## CH Channel / GR Group Adjustment

1. **CH Channel adjustment:** In normal status, short press GR/CH button once, and the channel value is selected. Turn the CCT select dial to choose channel from 1 to 32.
2. **GR Group adjustment:** In normal status, short press GR/CH button twice, and the group value is selected. Turn the CCT select dial to choose group from A, B or C.
3. Short short press the GR/CH button thrice to exit from wireless adjustment of channels and groups.

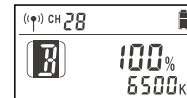
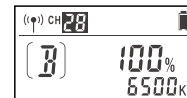

2. With smartphone APP control through Bluetooth, the operate panel can be connected to several LED lights to achieve convenient operation.

## Bluetooth connection

Scan the QR code to download the "Godox Light" smartphone APP (can be used by Android and Apple system).

For more smartphone APP operations, please open the "help" in APP to gain detailed guidance.





## Technical Data

Model	ES45 Kit
DC Power Supply by Adapter	Input: 100~240V 50/60Hz 1.3A Output: 14V 3.42A
Lithium Battery of Operate Panel	3.7V Lithium battery (built-in)
Power	Up to approx.56W in max. (color temperature: 4100K)
Channel	32(1~32)
Group	3(A, B, C)
Color Temperature	2800~6500K
100% Lumen (lm)	Max. 2500
100% Luminosity (lx) (darkroom, 0.5m distance)	Max. ≈ 4100
CRI	≥96
TLCI	≥97
Brightness Range	0~100%
Control Method	Smartphone APP/2.4G Wireless
Quantity of LED Beads	176
Working Environment Temperature	-10~40°C
Dimension	367*230*31.04mm (operate panel is not included) 367*230*45.9mm (operate panel is included)
Weight	≈ 1.33KG (operate panel is included)

\* Product design and specifications are subject to change without notice.

Note:

The MAC code check and Bluetooth password reset must be proceeded after the operate panel and main body have already been turned on and successfully connected.

1. MAC code check: when the operate panel and main body have been turned on, long press the GR/CH button for 2 seconds to enter the Bluetooth interface. The MAC code will be displayed on the top left.
2. Bluetooth password reset: in MAC code interface, turn the CCT select dial to choose  $\Psi_{ES}$ . Then, short press GR/CH button once, and the Bluetooth icon will be blinking, which means the password is reset. Turn the CCT select dial to choose . Then, short press the GR/CH button to back to the main interface.



## Standby Functions

1. The display of operate panel will get darker automatically after detached from the main light body and without operation for 1 minute.
2. The LED light will turn off automatically after detached from the main light body and without operation for 1 hour.

## Maintenance

Avoid sudden impacts and the product should be dedusted regularly.

This product, except consumables e.g. battery and adapter, is supported with a one-year warranty.

Maintenance of the flash must be performed by our authorized maintenance department which can provide original accessories.

Unauthorized service will void the warranty.

If the product had failures or was wetted, do not use it until it is repaired by professionals.

Changes made to the specifications or designs may not be reflected in this manual.

## FCC Statement

This device complies with part 15 of the FCC Rules. Operation is subject to the following two conditions: (1) This device may not cause harmful interference, and (2) this device must accept any interference received, including interference that may cause undesired operation.

Any Changes or modifications not expressly approved by the party responsible for compliance could void the user's authority to operate the equipment.

**Note:** This equipment has been tested and found to comply with the limits for a Class B digital device, pursuant to part 15 of the FCC Rules. These limits are designed to provide reasonable protection against harmful interference in a residential installation. This equipment generates uses and can radiate radio frequency energy and, if not installed and used in accordance with the instructions, may cause harmful interference to radio communications. However, there is no guarantee that interference will not occur in a particular installation. If this equipment does cause harmful interference to radio or television reception, which can be determined by turning the equipment off and on, the user is encouraged to try to correct the interference by one or more of the following measures:

- Reorient or relocate the receiving antenna.
- Increase the separation between the equipment and receiver.
- Connect the equipment into an outlet on a circuit different from that to which the receiver is connected.
- Consult the dealer or an experienced radio/TV technician for help.



# 产品保修

尊敬的用户，本保修卡是申请保修服务的重要凭证，请您配合销售商填写并妥善保管，谢谢！

产品信息	型号	产品条码
用户信息	姓名	联系电话
	通信地址	
销售商信息	名称	
	联系电话	
	通信地址	
	销售日期	
备注		

注：此表应由销售商盖章确认。

## 适用产品

本文件适用于相关《产品保修信息》(见后面说明)所列产品，其他非属此范围的产品或部件(如促销品、赠品及其他出厂后附加的部件等)不在此保修承诺内。

## 保修期

产品及部件的相应保修期按相关的《产品保修信息》执行。保修期自产品首次购买日起算，购买日以购买产品时保修卡登记日期为准。

## 如何获得保修服务

要保修服务，您可直接与产品销售商或授权服务机构联系，也可拨打神牛产品售后服务电话，与我们联系，由我们的服务人员为您安排服务。申请保修时，您应提供有效的保修卡作为保修凭证，方可获得保修。如您不能提供有效的保修卡，则在我们可确认产品或部件属于保修范围的情况下，也可以为您提供保修，但这不作为我们的义务。

## 不适用保修的情况

如产品存在下列情况，本文件项下的保证和服务将不适用 ①产品或部件超过相应保修期；②错误或不当使用、维护或保管导致的故障或损坏，如：不当搬运；非按产品合理预期用途使用；不当插拔外接设备；跌落或外力挤压；接触或暴露于不适当温度、溶剂、酸碱、水浸或潮湿环境；③由非神牛授权机构或人员安装、修理、更改、添加或拆卸造成的故障或损坏；④产品或部件原有识别信息被修改变更或删除；⑤无有效保修卡；⑥使用非合法授权、非标准或非公开发行的软件造成的故障或损坏；⑦因不可抗力或意外事件造成的故障或损坏；⑧其他非因产品本身质量问题导致的故障或损坏。遇上述情况，您应向相关责任方寻求解决，神牛对此不承担任何责任。因非在保修期或保修范围内的部件、附件或软件导致产品不能正常使用的，不是保修范围内的故障。产品使用过程中正常的脱色，磨损和消耗，不是保修范围内的故障。

## 产品保修和服务支持信息

产品的保修期和服务类型按以下《产品保修信息》执行：

产品类别	选项名称	保修期(月)	保修服务类型
部件	电路板	12	客户送修
	电池	3	客户送修
	充电器、电源线，同步线等带电性能的部件。	12	客户送修
其他	如闪光管、造型灯泡、外壳、保护罩、锁紧装置、包装等。	无	无保修

神牛产品售后服务电话 0755-29609320-8062

# Warranty

Dear customers, as this warranty card is an important certificate to apply for our maintenance service, please fill in the following form in coordination with the seller and safekeep it. Thank you!

Product Information	Model	Product Code Number
Customer Information	Name	Contact Number
	Address	
Seller Information	Name	
	Contact Number	
	Address	
	Date of Sale	
Note:		

Note: This form shall be sealed by the seller.

## Applicable Products

The document applies to the products listed on the **Product Maintenance Information** (see below for further information). Other products or accessories (e.g. promotional items, giveaways and additional accessories attached, etc.) are not included in this warranty scope.

## Warranty Period

The warranty period of products and accessories is implemented according to the relevant Product Maintenance Information. The warranty period is calculated from the date (purchase date) when the product is bought for the first time. And the purchase date is considered as the date registered on the warranty card when buying the product.

## How to Get the Maintenance Service

If maintenance service is needed, you can directly contact the product distributor or authorized service institutions. You can also contact the Godox after-sale service call and we will offer you service. When applying for maintenance service, you should provide valid warranty card. If you cannot provide valid warranty card, we may offer you maintenance service once confirmed that the product or accessory is involved in the maintenance scope, but that shall not be considered as our obligation.

## Inapplicable Cases

The guarantee and service offered by this document are not applicable in the following cases: ①. **The product or accessory has expired its warranty period;** ②. **Breakage or damage caused by inappropriate usage, maintenance or preservation, such as improper packing, improper usage, improper plugging in/out external equipment, falling off or squeezing by external force, contacting or exposing to the improper temperature, solvent, acid, base, flooding and damp environments, etc;** ③. **Breakage or damage caused by non-authorized institution or staff in the process of installation, maintenance, alternation, addition and detachment;** ④. **The original identifying information of product or accessory is modified, alternated, or removed;** ⑤. **No valid warranty card;** ⑥. **Breakage or damage caused by using illegally authorized, nonstandard or non-public released software;** ⑦. **Breakage or damage caused by force majeure or accident;** ⑧. **Breakage or damage that could not be attributed to the product itself.** Once met these situations above, you should seek solutions from the related responsible parties and Godox assumes no responsibility. The damage caused by parts, accessories and software that beyond the warranty period or scope is not included in our maintenance scope. The normal discoloration, abrasion and consumption are not the breakage within the maintenance scope.

## Maintenance and Service Support Information

The warranty period and service types of products are implemented according to the following **Product Maintenance Information**:

Product Type	Name	Maintenance Period(month)	Warranty Service Type
Parts	Circuit Board	12	Customer sends the product to designated site
	Battery	3	Customer sends the product to designated site
	Electrical parts e.g. battery charger, power cord, sync cable, etc.	12	Customer sends the product to designated site
Other Items	Flash tube, modeling lamp, lamp body, lamp cover, locking device, package, etc.	No	Without warranty

Godox After-sale Service Call **0755-29609320-8062**