

Godox

双色温LED摄影灯
Bi-color LED Video Light

SL150//Bi

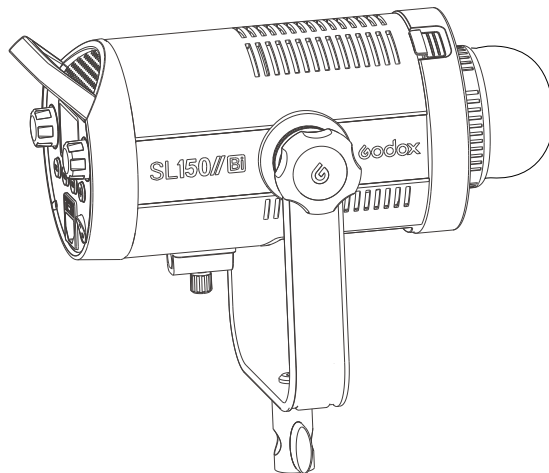

合格证
QC PASS

深圳市神牛摄影器材有限公司

地址: 深圳市宝安区福海街道塘尾社区福川工业区厂房2栋
电话: 0755-29609320(8062) 传真: 0755-25723423 邮箱: godox@godox.com

GODOX Photo Equipment Co., Ltd.

Add: Building 2, Yaochuan Industrial Zone, Tangwei Community, Fuhai Street, Bao'an District,
Shenzhen, China Tel: +86-755-29609320(8062) Fax: +86-755-25723423 E-mail: godox@godox.com

godox.com

Made in China



使用手册
Instruction Manual

前言

感谢您购买神牛产品！

双色温LED摄影灯SL150IIBi在原有SL150II系列摄影灯的基础上增加了双色温选择，可打造更多创意拍摄。功率强劲，光效柔和，适用范围广泛。

主要特点：

- 拥有色温可调功能，色温调节范围(2800K~6500K)
- 9种FX光效模式，模拟各种拍摄场景，轻松实现创意光效
- 静音模式：零噪音，无干扰
- 内置神牛2.4G无线功能，可无线调节LED灯
- 光源稳定，0%-100%精确调节亮度
- 16组32频道分组遥控
- U型支架设计，可吊装，方便调节各种高度
- 保荣卡口，支持安装各类光效附件
- LCD屏清晰显示
- 良好的散热性能

警告

- △ 请保持干燥：请勿用湿手接触产品，亦不可将产品浸入水中或暴露于雨中。
- △ 请勿私自拆卸产品，如产品出现故障须由本公司或授权的维修人员进行检查维修。
- △ 请勿让儿童接触本产品。
- △ 本产品不能防水，在雨天及潮湿环境下请注意防水。
- △ 请勿放置在超过40摄氏度的高温环境中。
- △ 请勿在化学品、可燃性气体或其他特殊物质附近使用LED灯。在这些场合下，请注意相关警告标识。
- △ 设备工作时会有发热现象，请小心触摸！

部件名称

· 灯体

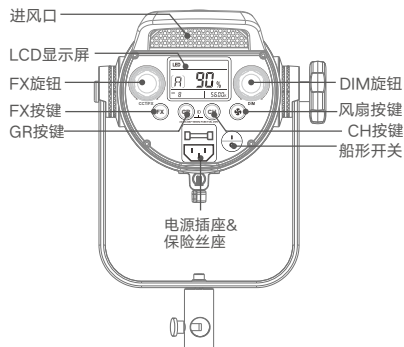
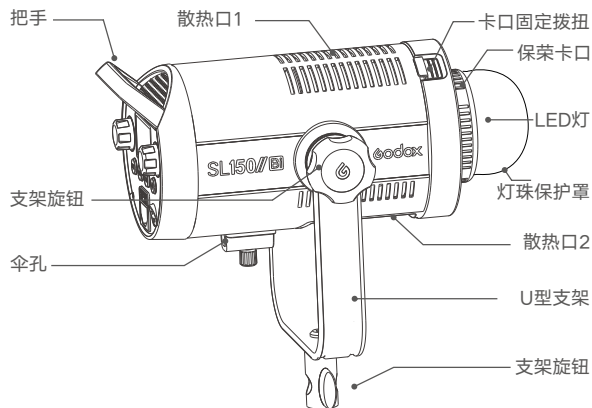

显示屏

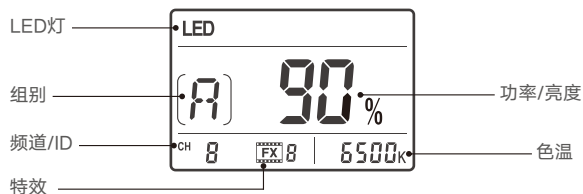

标配物品

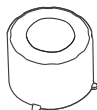
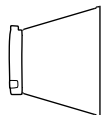
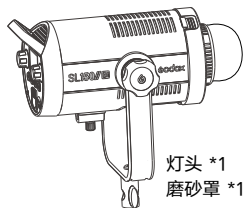

可选购附件

可搭配本公司以下摄影附件使用，以获得最佳的拍摄效果和使用体验：
RC-A6 遥控器、逆变器、柔光箱、反光伞、灯架、蜂巢、雷达罩、束光筒等

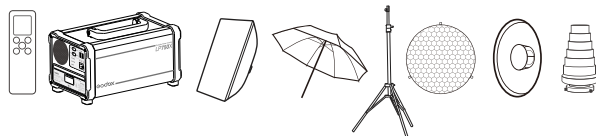

接通电源

通过电源线接通交流电源与LED灯，拨动LED灯上的电源开关至ON 即可开机。

操作说明

一、模式选择

1.1 LED静音模式：不打开风扇时为静音模式，静音模式零噪音，无干扰。静音模式时，亮度可调范围0%~50%。

1.2 LED光效模式：短按FX按键进入或退出光效模式。进入光效模式时显示屏显示FX，旋转FX旋钮选择光效场景。有9种FX光效模式，模拟各种拍摄场景，轻松实现创意光效。

显示	FX1	FX2	FX3	FX4	FX5	FX6	FX7	FX8	FX9
场景	Flash1	Flash2	Storm1	Storm2	TV	坏灯泡	蜡烛	火	烟花

*备注：光效模式下只支持显示6500K色温。

1.3 LED强光模式：打开风扇进入LED灯强光模式，强光模式时功率达到最大。

二、设置

亮度调节

旋转DIM旋钮调节亮度，亮度调节范围0%-100%，LCD显示屏将准确显示所设置的亮度。

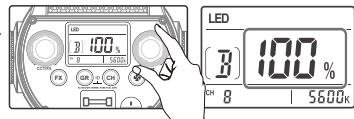

色温调节

在常亮LED灯模式下，旋转CCT/FX旋钮可以调节色温范围2800K~6500K,LCD显示屏将准确显示所设置的色温。

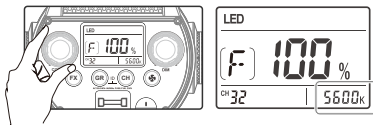

ID设置：同时长按GR和CH键进入ID设置界面，旋转DIM旋钮选择ID，ID选择范围：0F，01-99。

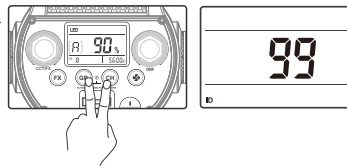

注：遥控器需要另外购买。

三、无线控制

双色温LED摄影灯SL150IIBi具备无线接收功能，使用遥控器RC-A6，可同时分别控制多个LED灯。32个频道，99个无线ID，抗干扰强。

注：使用前请把LED灯和RC-A6遥控器的频道(CH)、组别(GR)和ID调至一致。

组别GR、频道CH、ID设置

组别GR设置：短按GR按键，选择组别GR，组别选择范围：

A、B、C、D、E、F、0-9。

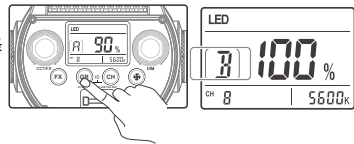

频道CH设置：短按CH按键，选择频道CH，频道选择范围：1-32。

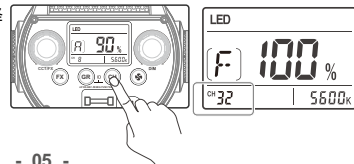

产品参数

摄影灯	SL150IIbi
供电	AC100V-240V(50/60HZ)
输出功率	150W
色温范围	2800~6500K
100%光照度(LUX, 1米距离)	≈30000
CRI ≈	96
TLCI ≈	97
常亮模式调光范围	0%-100%
工作环境温度	-10 ~ 40°C
频道	32个
组别	16组(A、B、C、D、E、F, 0-9)
产品尺寸(不含反光罩)	34x20x16cm
净量(不含反光罩和保护盖)	3.07Kg

* 设计和规格如有变更，恕不另行通知。

维护保养

- 为了防止灰尘的堆积影响到产品的性能，请定时用干净的湿布轻轻擦拭产品外部。
- 1年保修，消耗品电源线等配件不在此保修范围内。
- 对于不规范操作引起的机器故障不在保修范围内。
- 所有维修概由本厂指定可供原厂配件之维修部负责。
- 经发现，擅自检修本品，将取消一年保修期，维修需要收取相关费用。
- 如果本品出现故障或者被水淋湿，在专业人员维修后方可继续使用。
- 如有技术更改，恕不另行通知。

本设备包含型号核准代码为: CMIIT ID:2020DP13510, 为该产品的无线电发射模块。

IMPORTANT SAFETY INSTRUCTIONS

When using your photographic equipment, basic safety precautions should always be followed, including the following:

1. Read and understand all instructions before using.
2. Close supervision is necessary when any appliance is used by or near children. Do not leave appliance unattended while in use.
3. Care must be taken as burns can occur from touching hot parts.
4. The appliance switch is provided with the symbols 0 indicating off and 1 indicating on. The symbols and may be used for this purpose.
5. Do not operate appliance with a damaged cord or if the appliance has been dropped or damaged – until it has been examined by a qualified serviceman.
6. Position the cord so that it will not be tripped over, pulled, or contact hot surfaces.
7. If an extension cord is necessary, a cord with a current rating at least equal to that of the appliance should be used. Cords rated for less amperage than the appliance may overheat.
8. Always unplug appliance from electrical outlet before cleaning and servicing and when not in use. Never yank cord to pull plug from outlet. Grasp plug and pull to disconnect.
9. Let appliance cool completely before putting away. Loop cord loosely around appliance when storing.
10. To reduce the risk of electric shock, do not immerse this appliance in water or other liquids.
11. To reduce the risk of electric shock, do not disassemble this appliance, but take it to a qualified serviceman when service or repair work is required. Incorrect reassembly can cause electric shock when the appliance is used subsequently.
12. The use of an accessory attachment not recommended by the manufacturer may cause a risk of fire, electric shock, or injury to persons.
13. Connect this appliance to a grounded outlet.
14. Disconnect this unit from its source of supply before replacing the projection lamp.
15. This appliance has a polarized plug (one blade is wider than the other). To reduce the risk of electric shock, this plug is intended to fit in a polarized outlet only one way. If the plug does not fit fully in the outlet, reverse the plug. If it still does not fit, contact a qualified electrician. Do not modify the plug in any way.

SAVE THESE INSTRUCTIONS

Foreword







Thank you for purchasing this Godox Product!

With 8 special effects modes, strong power, soft illumination and abundant functions, Bi-color LED Video Light SL150IIbI can achieve creative shooting easily.

Main Features:

- With color temperature adjustment from 2800K to 6500K.
- With 9 FX special effects mode to simulate various of shooting scene.
- Silent mode: without noises and interference.
- Built-in Godox 2.4G wireless & wirelessly adjust parameters.
- With stable light source and 0% to 100% precise light adjustment.
- With 16 groups and 32 channels wireless control.
- With U-type bracket to adjust different angles easily.
- Bowens-mount enables to install various of accessories.
- Clear LCD display.
- Excellent heat dissipation.

Warning

-  Always keep this product dry. Do not use in rain or in damp conditions.
-  Do not disassemble. Should repairs become necessary, this product must be sent to an authorized maintenance center.
-  Keep out of reach of children.
-  As this product do not have waterproof function, please take measures of waterproof in rainy or damp environment.
-  Do not use the product in the presence of flammable gases, chemicals and other similar materials.
-  **CAUTION:** Hot parts!When the product is always on and flickering,please do not touch the high temperature part of the LED head. When replacing product accessories,please turn off the LED light and perform a cold cut.

Name of Body

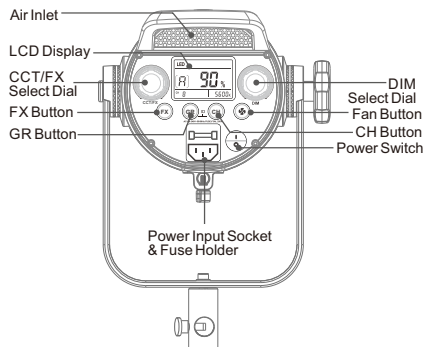
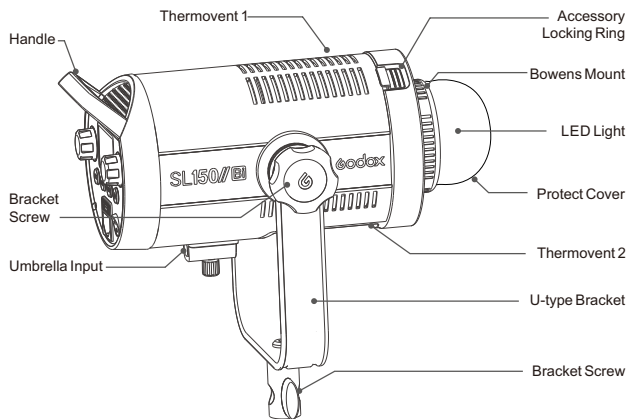

LCD Panel

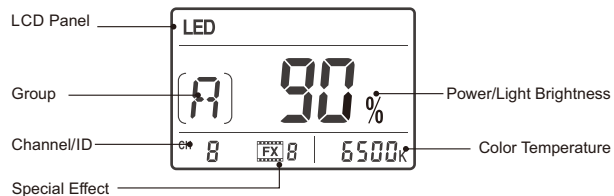

Included Items

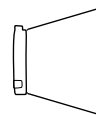
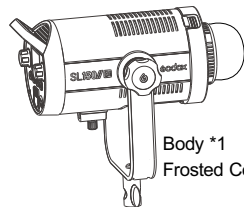

Separately Sold Accessories

The product can be used in combination with the following accessories sold separately, so as to achieve best photography effects: RC-A6 Remote Control, Power Inverter, Softbox, Photographic Umbrella, Light Stand, Barndoor, Snoot, etc.

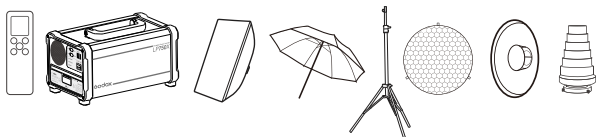

Power Connection

Use the power cord to connect the LED light to an AC power source and turn on the power switch.

Operation

Mode Selection

1.1 LED silent mode: in this mode, the fan is turned off. There is no noises and interference in this mode. In silent mode, the brightness adjustment range is from 0% to 50%.

1.2 LED special effects modes: Short press the FX button to enter or exit the special effects. When entering the FX modes, FX icon will be displayed on the LCD panel. Then, turn the FX select dial to choose one mode from the 9 special effects modes to achieve creative shooting.

Display	FX1	FX2	FX3	FX4	FX5	FX6	FX7	FX8	FX9
Scene	Flash1	Flash2	Storm1	Storm2	TV	Broken bulb	Camdle	Fire	Firework

Note: Only 6500K color temperature can be displayed in special effects mode.

1.3 LED strong power mode: turn on the fan to enter LED strong power mode and the power will up to the maximum value in this mode.

Light Brightness Adjustment

In LED mode, the light brightness of LED light can be adjusted by turning the DMX select dial from 0% to 100%. And the light brightness will be clearly displayed on the LCD Panel.

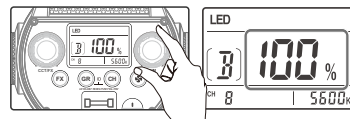

Color Temperature Adjustment

In continuous LED mode, turn the CCT/FX select dial to adjust color temperature from 2800K to 6500K. And the color temperature value will be precisely displayed.

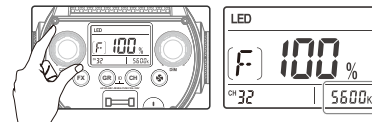

Group GR, Channel CH and ID Setting

GR Setting: Short press GR button to choose group from A, B, C, D, E, F and 0 to 9.

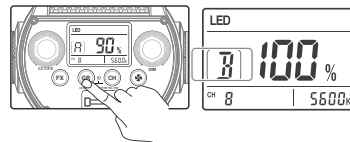

CH Setting: Short press CH button to choose channel from 1 to 32.

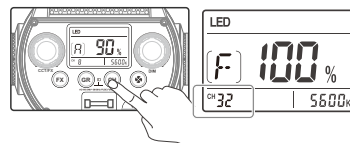

ID Setting: Long press GR and CH button to enter ID setting interface. Then, turn the DIM select dial to choose ID from 0F and 01 to 99.

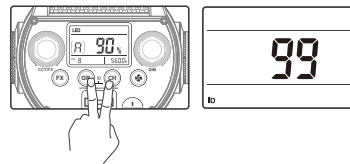

Wireless Control

With 2.4G wireless system, Bi-color LED Video Light SL150IIBi have receive and control function. Up to multiple groups of LED lights can be controlled. 32 channels and 99 wireless IDs are available with strong anti-interference capability. Please set the channels, groups and IDs of LED light to the same as those of RC-A6 remote control before usage.

Adjusting Channel/Group with the Remote Control

- Press the CH/GR button and the group icon blinks.
Press the "-" "+" button to choose a group (A to F, 0 to 9).
- Press the CH/GR button twice and the channel icon blinks.
Press the "-" "+" button to choose a channel (1 to 32).

Adjusting ID with the Remote Control

- Double click the CH/GR button and press the "-" "+" button to choose ID from OFF or 01 to 99.

Adjusting Light Brightness with the Remote Control

- Press the "-" "+" button to adjust the light brightness.
Adjusting Color Temperature with the Remote Control
- Press the SET button of the remote control and the color temperature icon blinks. Press the "-" "+" button to adjust the color temperature.

Remote control reset: press down "-" and "+" button simultaneously to reset.

Note: The wireless signal can be received only when the controller of LED light is powered on.

Setting color temperature range

The factory setting of remote control's color temperature range is 2800-6500K. In order to use remote control conveniently, color temperature range settings are added: when the remote control is off, hold down the SET button and turn it on to enter color temperature adjusting interface. Press CH/GR button to switch the lowest and highest color temperature value and press "-" or "+" button to change the value. Press the SET button to confirm it.

Note: the remote control needs to be purchased separately.

Technical Data

LED Video Light	SL150IIBi
Power Supply	AC100V-240V(50/60HZ)
Output Power	150W
Color Temperature Range	2800~6500K
100% Light Brightness(LUX, 1M)	≈30000
CRI ≈	96
TLCI ≈	97
Light Brightness Range	0%-100%
Operation Temperature	-10 ~ 40°C
Channel	32
Group	16(A, B, C, D, E, F, 0-9)
Dimension (not included a standard reflector)	34x20x16cm
Net Weight(not include reflector and protect cover)	3.07Kg

* Product design and specifications are subject to change without notice.

Maintenance

This product, except consumables e.g. cable, is supported with a one-year warranty. Avoid sudden impacts and the product should be dedusted regularly.

Maintenance of the flash must be performed by our authorized maintenance department which can provide original accessories.

Unauthorized service will void the warranty.

If the product had failures or was wetted, do not use it until it is repaired by professionals.

Changes made to the specifications or designs may not be reflected in this manual.

FCC Statement

This device complies with part 15 of the FCC Rules. Operation is subject to the following two conditions: (1) This device may not cause harmful interference, and (2) this device must accept any interference received, including interference that may cause undesired operation.

Any Changes or modifications not expressly approved by the party responsible for compliance could void the user's authority to operate the equipment.

Note: This equipment has been tested and found to comply with the limits for a Class B digital device, pursuant to part 15 of the FCC Rules. These limits are designed to provide reasonable protection against harmful interference in a residential installation. This equipment generates uses and can radiate radio frequency energy and, if not installed and used in accordance with the instructions, may cause harmful interference to radio communications. However, there is no guarantee that interference will not occur in a particular installation. If this equipment does cause harmful interference to radio or television reception, which can be determined by turning the equipment off and on, the user is encouraged to try to correct the interference by one or more of the following measures:

- Reorient or relocate the receiving antenna.
- Increase the separation between the equipment and receiver.
- Connect the equipment into an outlet on a circuit different from that to which the receiver is connected.
- Consult the dealer or an experienced radio/TV technician for help.

产品保修

尊敬的用户，本保修卡是申请保修服务的重要凭证，请您配合销售商填写并妥善保管，谢谢！

产品信息	型号	产品条码
用户信息	姓名	联系电话
	通信地址	
销售商信息	名称	
	联系电话	
	通信地址	
	销售日期	
备注		

注：此表应由销售商盖章确认。

适用产品

本文件适用于相关《产品保修信息》(见后面说明)所列产品，其他非属此范围的产品或部件(如促销品、赠品及其他出厂后附加的部件等)不在此保修承诺内。

保修期

产品及部件的相应保修期按相关的《产品保修信息》执行。保修期自产品首次购买日起算，购买日以购买产品时保修卡登记日期为准。

如何获得保修服务

您可直接与产品销售商或授权服务机构联系，也可拨打神牛产品售后服务电话，与我们联系，由我们的服务人员为您安排服务。申请保修时，您应提供有效的保修卡作为保修凭证，方可获得保修。如您不能提供有效的保修卡，则在我们确认产品或部件属于保修范围的情况下，也可以为您提供保修，但这不作为我们的义务。

不适用保修的情况

如产品存在下列情况，本文件项下的保证和服务将不适用 ①产品或部件超过相应保修期；②错误或不当使用、维护或保管导致的故障或损坏，如：不当搬运；非按产品合理预期用途使用；不当插拔外接设备；跌落或外力挤压；接触或暴露于不适当温度、溶剂、酸碱、水浸或潮湿环境；③由非神牛授权机构或人员安装、修理、更改、添加或拆卸造成的故障或损坏；④产品或部件原有识别信息被修改变更或删除；⑤无有效保修卡；⑥使用非合法授权、非标准或非公开发行的软件造成的故障或损坏；⑦因不可抗力或意外事件造成的故障或损坏；⑧其他非因产品本身质量问题导致的故障或损坏。遇上述情况，您应向相关责任方寻求解决，神牛对此不承担任何责任。因非在保修期或保修范围内的部件、附件或软件导致产品不能正常使用的，不是保修范围内的故障。产品使用过程中正常的脱色，磨损和消耗，不是保修范围内的故障。

产品保修和服务支持信息

产品的保修期和服务类型按以下《产品保修信息》执行：

产品类别	选项名称	保修期(月)	保修服务类型
部件	电路板	12	客户送修
	电池	3	客户送修
	充电器、电源线，同步线等带电性能的部件。	12	客户送修
其他	如闪光管、造型灯泡、外壳、保护罩、锁紧装置、包装等。	无	无保修

神牛产品售后服务电话 0755-29609320-8062

Warranty

Dear customers, as this warranty card is an important certificate to apply for our maintenance service, please fill in the following form in coordination with the seller and safe-keep it. Thank you!

Product Information	Model	Product Code Number
Customer Information	Name	Contact Number
	Address	
Seller Information	Name	
	Contact Number	
	Address	
	Date of Sale	
Note:		

Note: This form shall be sealed by the seller.

Applicable Products

The document applies to the products listed on the **Product Maintenance Information** (see below for further information). Other products or accessories (e.g. promotional items, giveaways and additional accessories attached, etc.) are not included in this warranty scope.

Warranty Period

The warranty period of products and accessories is implemented according to the relevant Product Maintenance Information. The warranty period is calculated from the day(purchase date) when the product is bought for the first time, And the purchase date is considered as the date registered onthe warranty card when buying the product.

How to Get the Maintenance Service

If maintenance service is needed, you can directly contact the product distributor or authorized service institutions. You can also contact the Godox after-sale service call and we will offer you service. When applying for maintenance service, you should provide valid warranty card. If you cannot provide valid warranty card, we may offer you maintenance service once confirmed that the product or accessory is involved in the maintenance scope, but that shall not be considered as our obligation.

Inapplicable Cases

The guarantee and service offered by this document are not applicable in the following cases: ①. **The product or accessory has expired its warranty period;** ②. **Breakage or damage caused by inappropriate usage, maintenance or preservation, such as improper packing, improper usage, improper plugging in/out external equipment, falling off or squeezing by external force, contacting or exposing to the improper temperature, solvent, acid, base, flooding and damp environments, etc;** ③. **Breakage or damage caused by non-authorized institution or staff in the process of installation, maintenance, alternation, addition and detachment;** ④. **The original identifying information of product or accessory is modified, alternated, or removed;** ⑤. **No valid warranty card;** ⑥. **Breakage or damage caused by using illegally authorized, nonstandard or non-public released software;** ⑦. **Breakage or damage caused by force majeure or accident;** ⑧. **Breakage or damage that could not be attributed to the product itself.** Once met these situations above, you should seek solutions from the related responsible parties and Godox assumes no responsibility. The damage caused by parts, accessories and software that beyond the warranty period or scope is not included in our maintenance scope. The normal discoloration, abrasion and consumption are not the breakage within the maintenance scope.

Maintenance and Service Support Information

The warranty period and service types of products are implemented according to the following **Product Maintenance Information**:

Product Type	Name	Maintenance Period(month)	Warranty Service Type
Parts	Circuit Board	12	Customer sends the product to designated site
	Battery	3	Customer sends the product to designated site
	Electrical parts e.g.battery charger, power cord, sync cable, etc.	12	Customer sends the product to designated site
Other Items	Flash tube, modeling lamp, lamp body, lamp cover, lockingdevice, package, etc.	No	Without warranty

Godox After-sale Service Call **0755-29609320-8062**